

AMMP-6530

5–30 GHz Image Reject Mixer

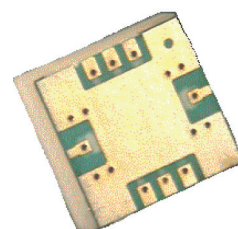

Data Sheet



Description

Avago Technologies' AMMP-6530 is an image reject mixer that operates from 5 GHz to 30 GHz. The cold channel FET mixer is designed to be an easy-to-use component for any surface mount PCB application. It can be used drain pumped for low conversion loss applications, or when gate pumped the mixer can provide high linearity for SSB up-conversion. An external 90-degree hybrid is used to achieve image rejection and a -1V voltage reference is needed. Intended applications include microwave radios, 802.16, VSAT, and satellite receivers. Since this one mixer can cover several bands, the AMMP-6530 can reduce part inventory. The integrated mixer eliminates complex tuning and assembly processes typically required by hybrid (discrete-FET or diode) mixers. The package is fully SMT compatible with backside grounding and I/O to simplify assembly.

Package Diagram

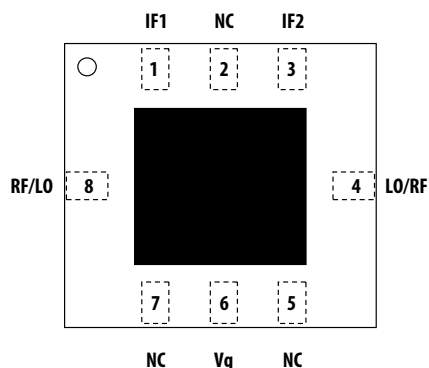

Features

- 5x5 mm Surface Mount Package
- Broad Band Performance 5– 30 GHz
- Low Conversion Loss of 8 dB
- High Image Rejection of 15–20 dB
- Good 3rd Order Intercept of +18 dBm
- Single -1V, no current Supply Bias

Applications

- Microwave Radio Systems
- Satellite VSAT, DBS Up/Down Link
- LMDS & Pt-Pt mmW Long Haul
- Broadband Wireless Access (including 802.16 and 802.20 WiMax)
- WLL and MMDS loops

Functional Block Diagram

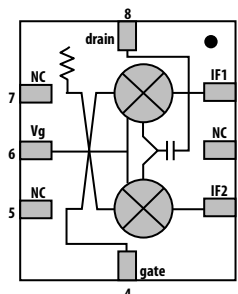

| Pin | Function |
|-----|----------|
| 1 | IF1 |
| 2 | |
| 3 | IF2 |
| 4 | LO/RF |
| 5 | |
| 6 | Vg |
| 7 | |
| 8 | RF/LO |

Top view
package base: GND



Attention: Observe precautions for handling electrostatic sensitive devices.
 ESD Machine Mode (Class A): 40V
 ESD Human Body Model (Class 0): 200V
 Refer to Avago Application Note A004R: *Electrostatic Discharge Damage and Control.*

Note: MSL Rating - Level 2A

Electrical Specifications

1. Small/Large -signal data measured in a fully de-embedded test fixture form TA = 25°C.
2. Pre-assembly into package performance verified 100% on-wafer per AMMC-6530 published specifications.
3. This final package part performance is verified by a functional test correlated to actual performance at one or more frequencies.
4. Specifications are derived from measurements in a 50 Ω test environment. Aspects of the amplifier performance may be improved over a more narrow bandwidth by application of additional conjugate, linearity, or low noise (Γopt) matching.
5. NF is measure on-wafer. Additional bond wires (-0.2nH) at Input could improve NF at some frequencies.

Table 1. RF Electrical Characteristics [1,2]

TA=25°C, Zo=50 Ω, Vg=1V, IF=1GHz

| Parameter | Down Conversion | Up Conversion | Down Conversion | Unit | Notes |
|---|--------------------|---------------------|-----------------|------|-------|
| LO Port Pumping Power, PLO | >10 | >0 | >10 | dBm | |
| RF to IF conversion Gain, CG | -10 | -15 | -8 | dB | |
| RF Port Return loss, RL_RF | 5 | 5 | 10 | dB | |
| LO Port Return loss, RL_LO | 10 | 10 | 5 | dB | |
| IF Port Return loss, RL_IF | 10 | 10 | 10 | dB | |
| Image Rejection Ratio, IR | 15 | 15 | 15 | dB | |
| LO to RF Port Isolation, LO-RF Iso. | 22 | 25 | 22 | dB | |
| LO to IF Port Isolation, LO-IF Iso. | 25 | 25 | 25 | dB | |
| RF to IF Port Isolation, RF-IF Iso. | 15 | 15 | 15 | dB | |
| Input IP3, Fdelta=100 MHz, IIP3 Prf = -10 dBm, Plo = 10 dBm | 18 | - | 10 | dBm | |
| Input Port Power at 1dB gain, P-1 compression point, Plo=+10 dBm | 8 | - | 0 | dBm | |
| Noise Figure, NF | 10 | - | 12 | dB | |
| | Gate Pumped | Drain Pumped | | | |
| FF Frequency Range, FRF | 5-30 | 5-30 | | GHz | |
| LO Frequency Range, FLO | 5-30 | 5-30 | | GHz | |
| IF Frequency Range, FIF | DC-5 | DC-5 | | | |

Table 2. Recommended Operating Range

1. Ambient operational temperature TA = 25°C unless otherwise noted.
2. The external 90 degree hybrid coupler is from M/A-COM: PN 2032-6344-00. Frequency 1.0– 2.0 GHz.
3. 100% on-package test is done at RF frequency = 21 GHz, LO frequency = 23 GHz (IF frequency = 2 GHz)
4. Channel-to-backside Thermal Resistance (Tchannel (Tc) = 34°C) as measured using infrared microscopy. Thermal Resistance at backside temperature (Tb) = 25°C calculated from measured data.

| Parameter | Min. | Typical | Max. | Unit | Notes |
|--------------------------------------|-------|---------|------|------|--|
| Gate Supply Current, Ig | | 0 | | mA | Under any RF power drive and temperature |
| Gate Supply Operating Voltage, Vg | | -1V | | V | |
| Min Ambient Operating Voltage, Tmins | -55 | | | °C | |
| Max Ambient Operating Voltage, Tmax | | | +125 | °C | |
| Conversion Gain, CG | -12.5 | -8 | | dB | |
| Image Rejection Ratio, IR | | 20 | | dB | |

Absolute Minimum and Maximum Ratings

Table 3. Minimum and Maximum Ratings

| Description | Min. | Max. | Unit | Notes |
|------------------------------------|------|------|------|-------------------|
| Gate Voltage Supply, Vg | 0 | -3 | V | |
| RF CW Input Power, Pin | | 25 | dBm | |
| Operating Channel Temperature, Tch | | +150 | dB | |
| Storage Temperature, Tstg | -65 | +150 | °C | |
| Maximum Assembly Temperature, Tmax | | 260 | °C | 20 second maximum |

Notes:

1. Operation in excess of any one of these conditions may result in permanent damage to this device.

AMMP-6530 Typical Performance under Gate Pumped Down Conversion Operation ($T_A = 25^\circ\text{C}$, $V_g = -1\text{V}$, $Z_o = 50\Omega$)

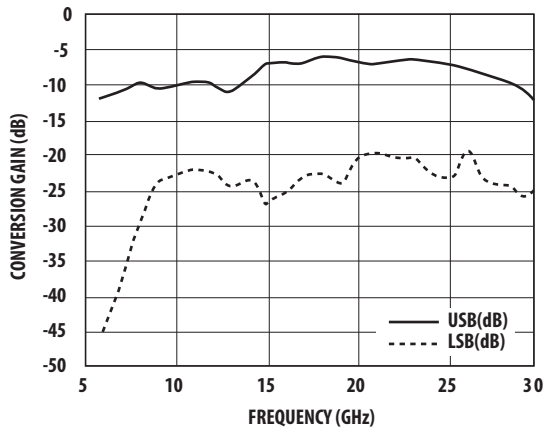
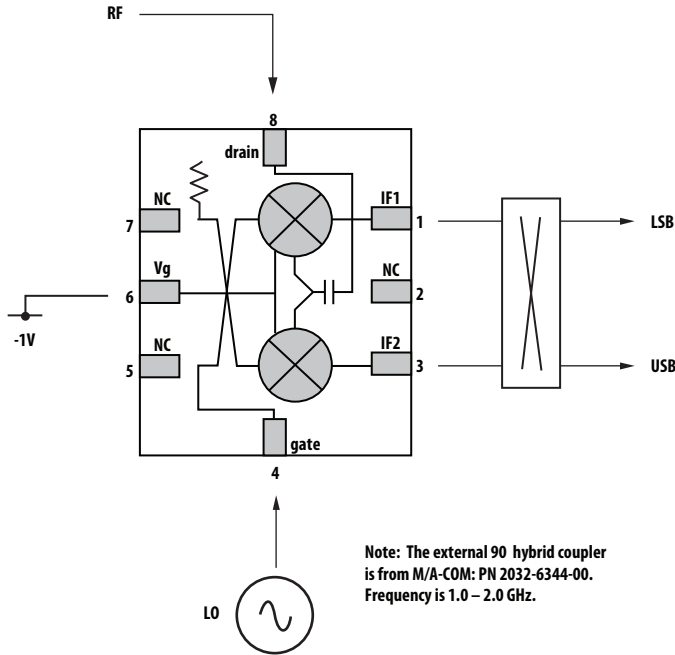

Figure 1. Conversion Gain with IF terminated for High Side Conversion

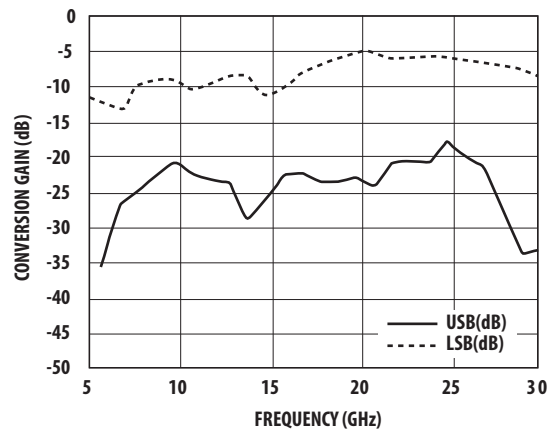

Figure 2. Conversion Gain with IF terminated for Low Side Conversion

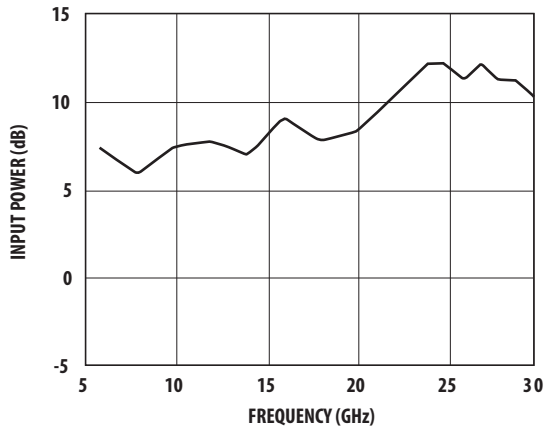

Figure 3. RF Port Input Power P-1dB. LO=+10 dBm, IF=1 GHz.

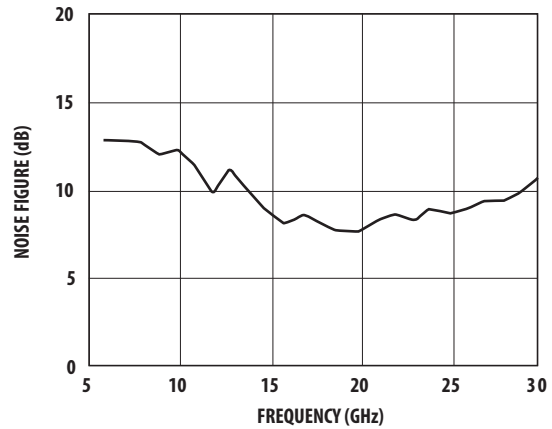

Figure 4. Noise Figure. LO=+7 dBm, IF=1 GHz.

AMMP-6530 Typical Performance under Gate Pumped Down Conversion Operation ($T_A = 25^\circ\text{C}$, $V_g = -1\text{V}$, $Z_o = 50\Omega$)

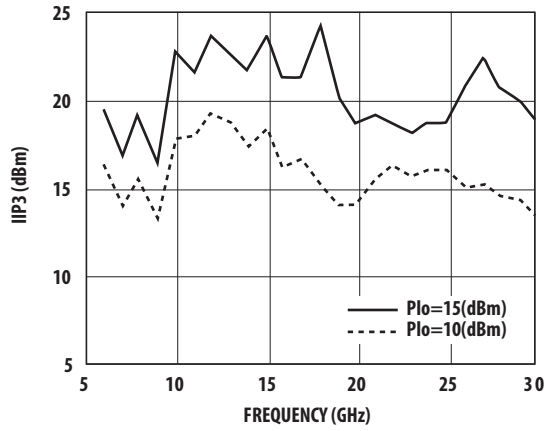

Figure 5. Input 3rd Order Intercept Point. IF=1 GHz.

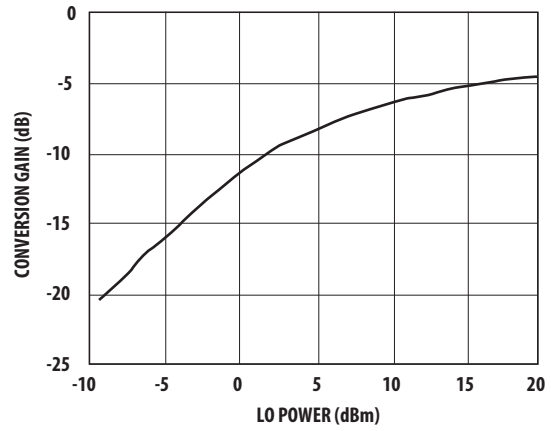

Figure 6. Conversion Gain vs. LO Power. RF=21 GHz (-20 dBm), LO=20 GHz.

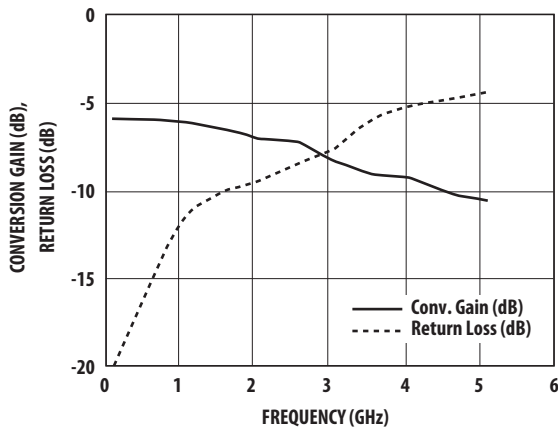

Figure 7. Conversion Gain and Match vs. IF Frequency. RF=20 GHz, LO=10 dBm.

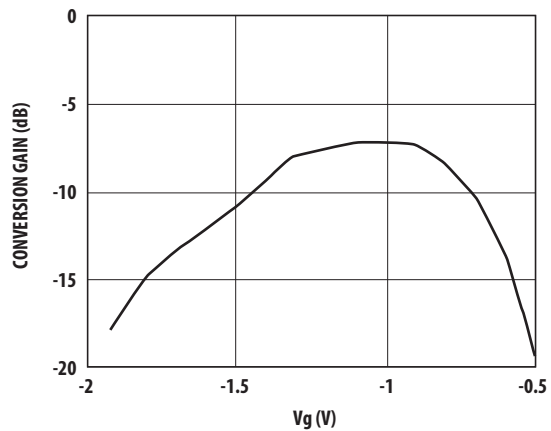

Figure 8. Conversion Gain vs. Gate Voltage. RF=20 GHz, LO=10 dBm.

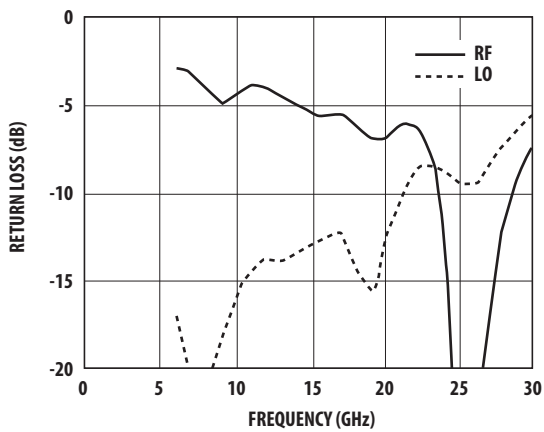

Figure 9. RF & LO Return Loss. LO=10 dBm.

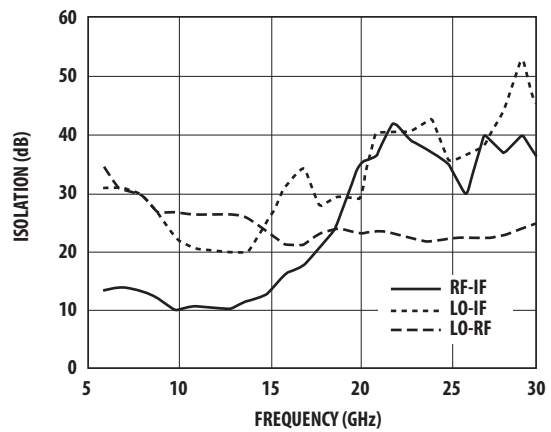

Figure 10. Isolation. LO=+10 dBm, IF=1 GHz.

AMMP-6530 Typical Performance under Gate Pumped Up Conversion Operation ($T_A = 25^\circ\text{C}$, $V_g = -1\text{V}$, $Z_0 = 50\Omega$)

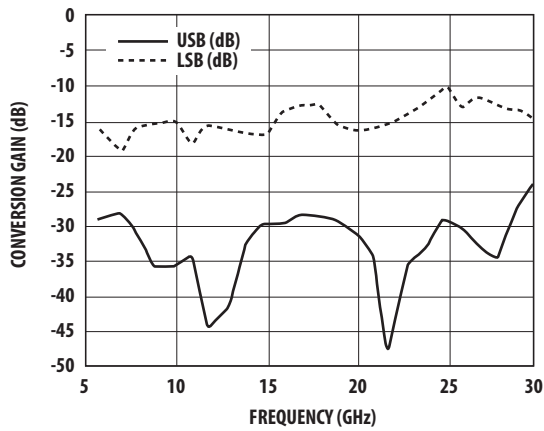
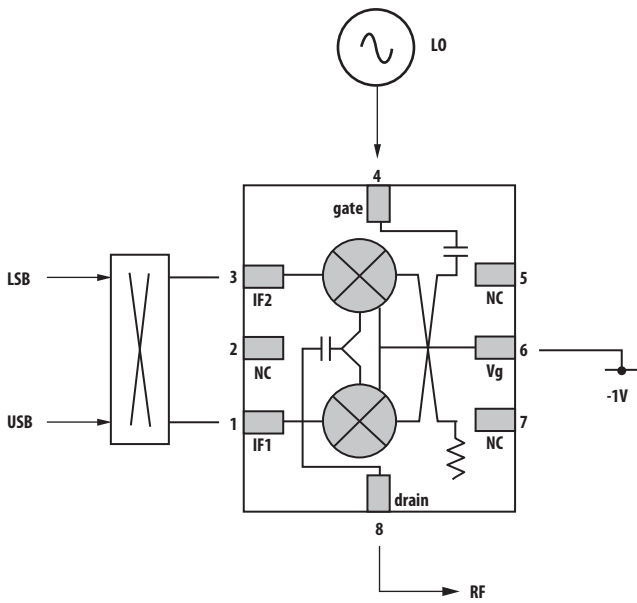

Figure 11. Up-conversion Gain with IF terminated for Low Side Conversion. $LO = +5\text{ dBm}$, $IF = +5\text{ dBm}$, $IF = 1\text{ GHz}$.

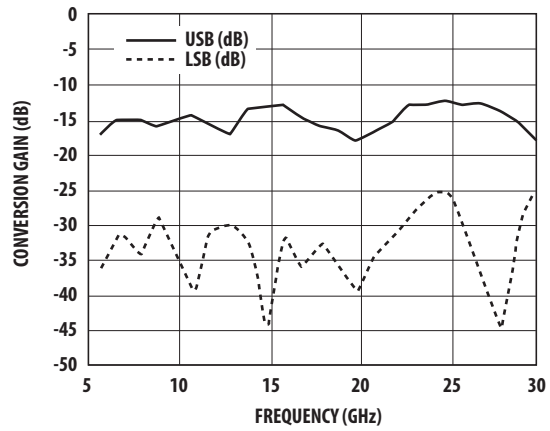

Figure 12. Up-conversion Gain with IF terminated for High Side Conversion. $LO = +5\text{ dBm}$, $IF = +5\text{ dBm}$, $IF = 1\text{ GHz}$.

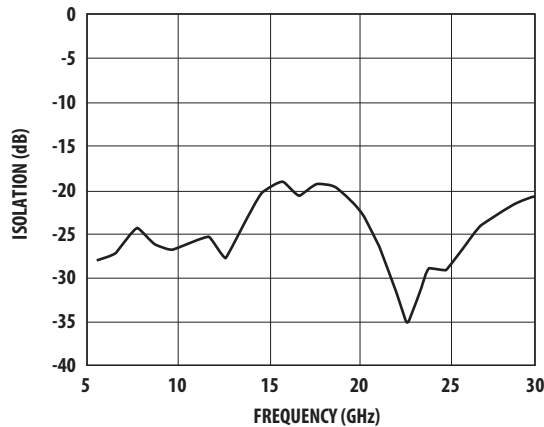

Figure 13. LO-RF Up-conversion Isolation.

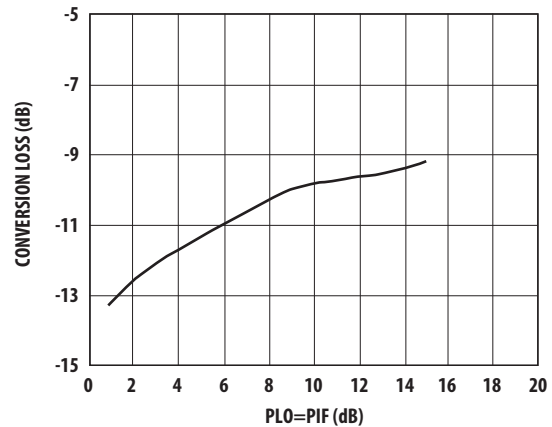

Figure 14. Up-conversion Gain vs. Pumping Power. $LO\text{ power} = IF\text{ power}$, $IF = 1\text{ GHz}$, $RF = 25\text{ GHz}$.

AMMP-6530 Typical Performance under Drain Pumped Down Conversion Operation
 ($T_A = 25^\circ\text{C}$, $V_g = -1\text{V}$, $Z_o = 50\Omega$)

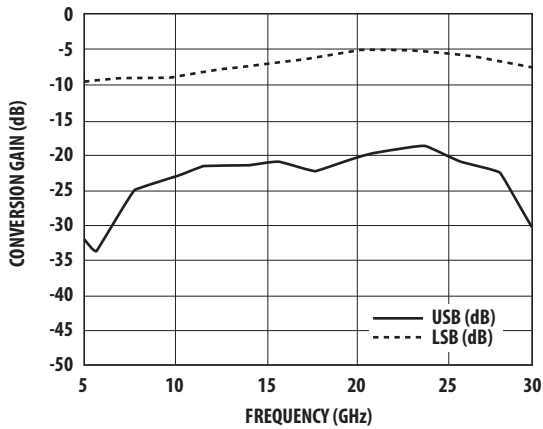
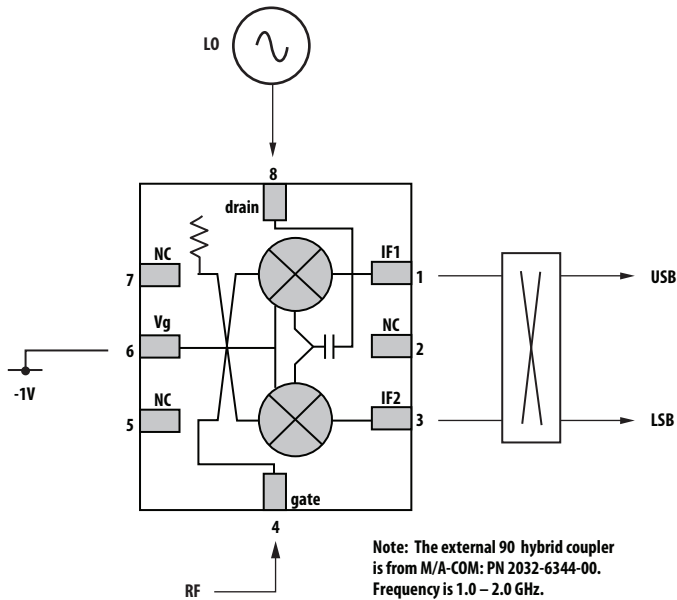

Figure 15. Conversion Gain with IF terminated for Low Side Conversion. LO=+10 dBm, IF=1 GHz.

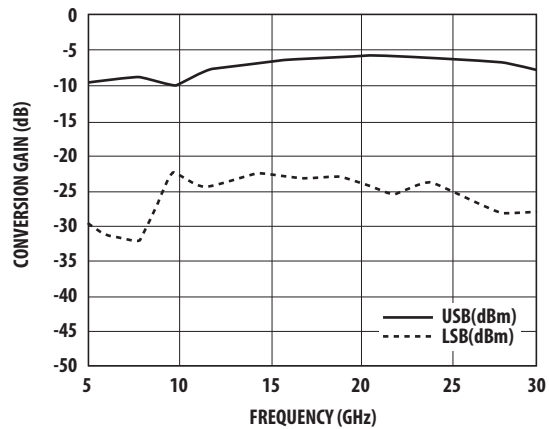

Figure 16. Conversion Gain with IF terminated for High Side Conversion. LO=+10 dBm, IF=1 GHz.

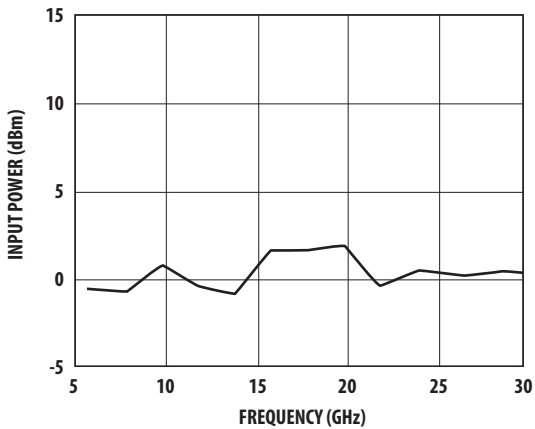

Figure 17. RF Port Input Power P-1dB. LO=+10 dBm, IF=1 GHz.

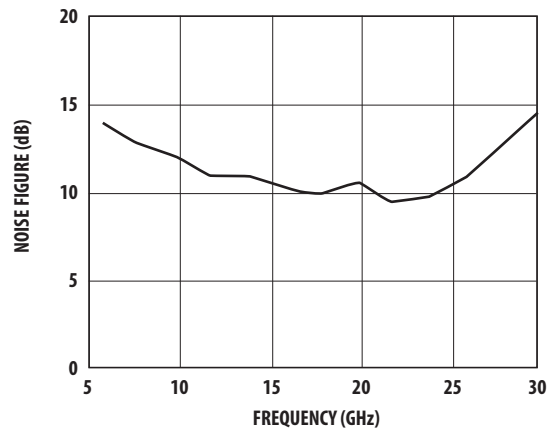

Figure 18. Noise Figure. LO=+7 dBm, IF=1 GHz.

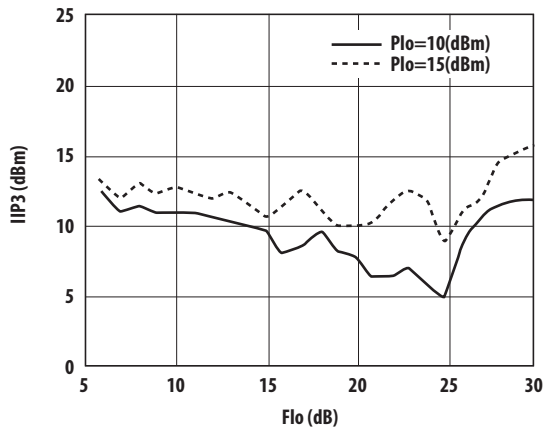

Figure 19. Input 3rd Order Intercept Point. IF=1 GHz.

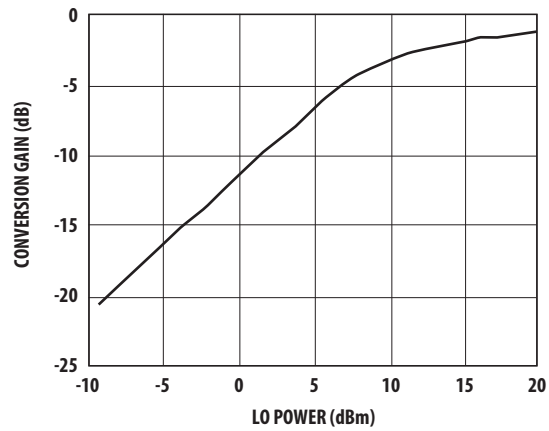

Figure 20. Conversion Gain vs. LO power. RF=21 GHz (-20 dBm), LO=20 GHz.

Biasing and Operation

The recommended DC bias condition for optimum performance, and reliability is $V_g = -1$ volts. There is no current consumption for the gate biasing because the FET mixer was designed for passive operation. For down conversion, the AMMP-6530 may be configured in a low loss or high linearity application. In a low loss configuration, the LO is applied through the drain (Pin8, power divider side). In this configuration, the AMMP-6530 is a “drain pumped mixer”. For higher linearity applications, the LO is applied through the gate (Pin4, Lange coupler side). In this configuration, the AMMP-6530 is a “gate pumped mixer” (or Resistive mixer). The mixer is also suitable for up-conversion applications under the gate pumped mixer operation shown on page 3.

Please note that the image rejection and isolation performance is dependent on the selection of the low frequency quadrature hybrid. The performance specification of the low frequency quadrature hybrid as well as the phase balance and VSWR of the interface to the AMMP-6530 will affect the overall mixer performance.

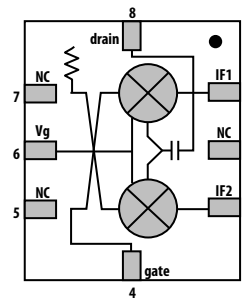

Figure 21. Simplified MMIC Schematic.

Package Dimension, PCB Layout and Tape and Reel information

Please refer to Avago Technologies Application Note 5520, AMxP-xxxx production Assembly Process (Land Pattern A).

Part Number Ordering Information

| Part Number | Devices per Container | Container |
|---------------|-----------------------|----------------|
| AMMP-6530-BLK | 10 | antistatic bag |
| AMMP-6530-TR1 | 100 | 7" Reel |
| AMMP-6530-TR2 | 500 | 7" Reel |

For product information and a complete list of distributors, please go to our web site: www.avagotech.com

Avago, Avago Technologies, and the A logo are trademarks of Avago Technologies in the United States and other countries.
Data subject to change. Copyright © 2005-2013 Avago Technologies. All rights reserved. Obsoletes AV01-0409EN
AV02-0502EN - July 9, 2013

