

Peak Emission Wavelength: 1650nm



Description

- Size 1206: 3.2 (L) x 1.6 (W) x 1.2 (H) mm
- Circuit substrate: glass laminated epoxy
- Devices are RoHS conform
- Lead free solderable, soldering pads: gold plated
- Taped in 8 mm blister tape, cathode to transporting perforation
- All devices are sorted into radiant intensity classes
- High radiation intensity types

Absolute Maximum Ratings (Ta=25°C)



ITEMS	SYMBOL	RATINGS	UNIT
Forward DC Current	If	50	mA
Peak Forward Current *	Ifp	100	mA
Reverse Voltage	Vr	5	V
Reverse Current	Ir	100	uA
Operating Temperature	Top	-40 to +85	°C
Storage Temperature	Tst	-55 to +85	°C
Thermal Resistance	RthJA	450	K/W

* tp ≤ 100 us, T=1:10

Electrical & Optical Characteristics (Ta = 25°C)

ITEMS	SYMBOL	MIN	TYP	MAX	UNIT
Forward Current	If	--	--	50	mA
Forward Voltage	Vf	--	1.0	1.3	V
Peak Wavelength	λp	1600	1650	1700	nm
Power Output	Po	--	1.7	--	mW
Spectral Width	Δλ0.5	--	130	--	nm

Package Dimensions

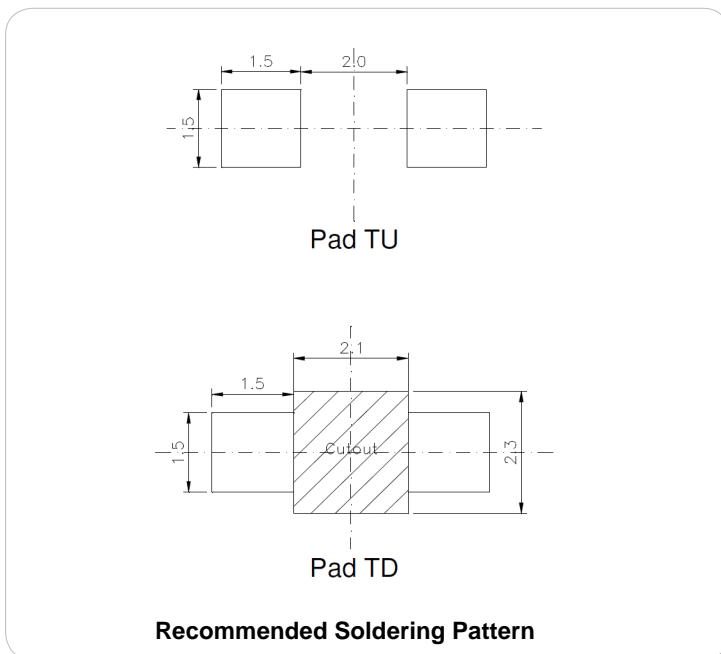
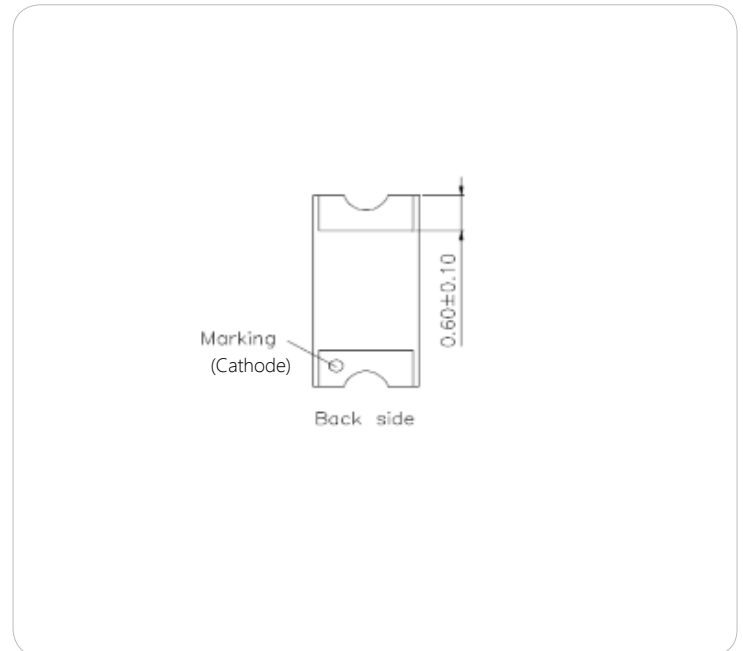
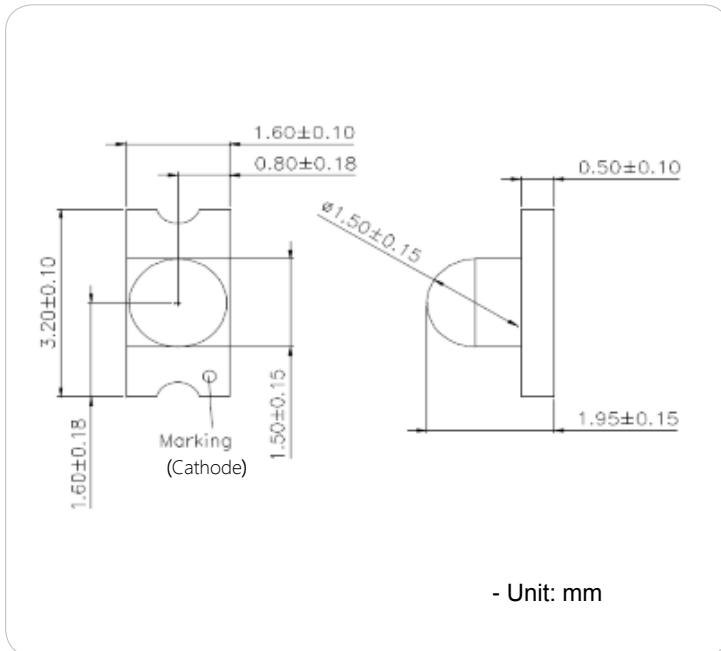

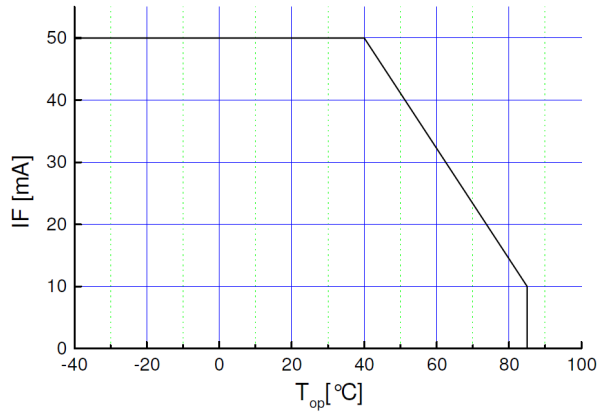

**Maximal
forward
current (DC)
characteristic**

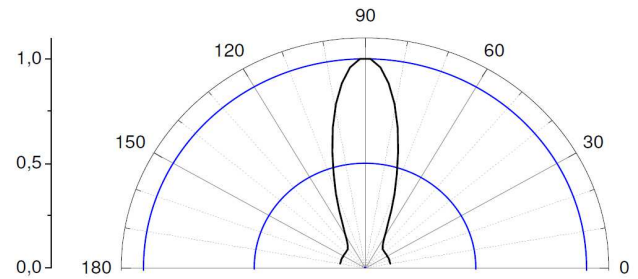

View angle

IR reflow soldering profile

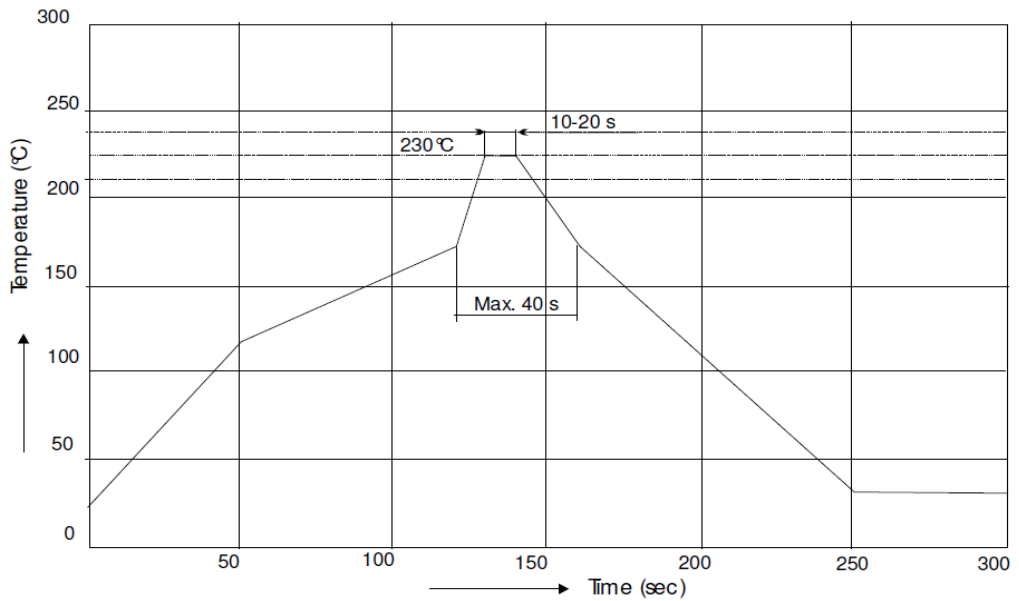

IR reflow soldering profile for lead free soldering

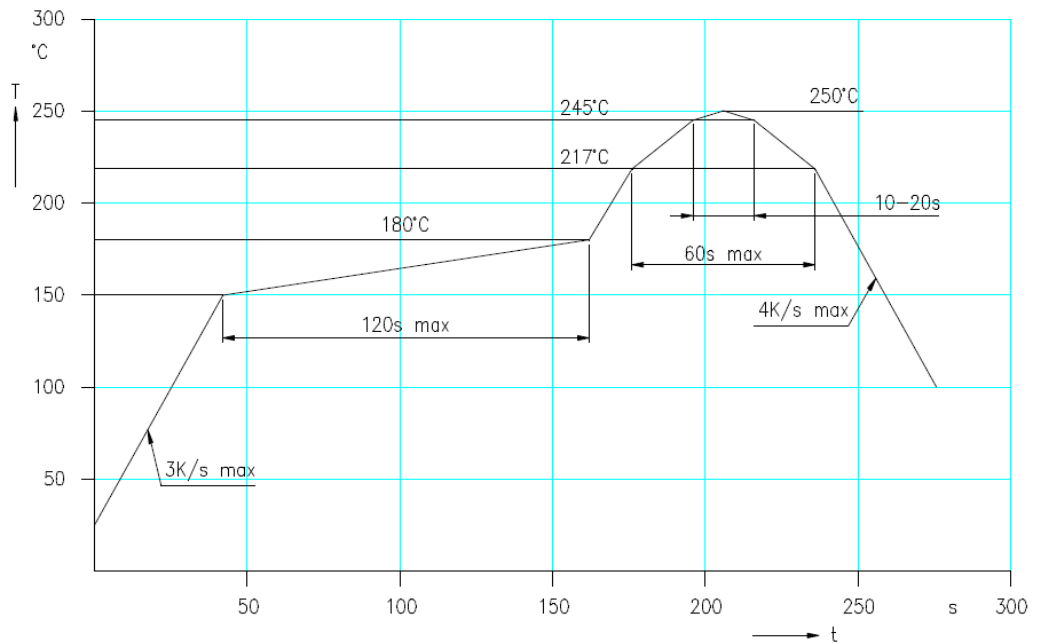

Manual soldering:
max power of iron 25 W / 3 s / 300°C

Measured according to CIE 127. All SMD-LEDs are 100% measured and selected on full automated equipment with an accuracy of $\pm 11\%$.

Tape and Reel packing

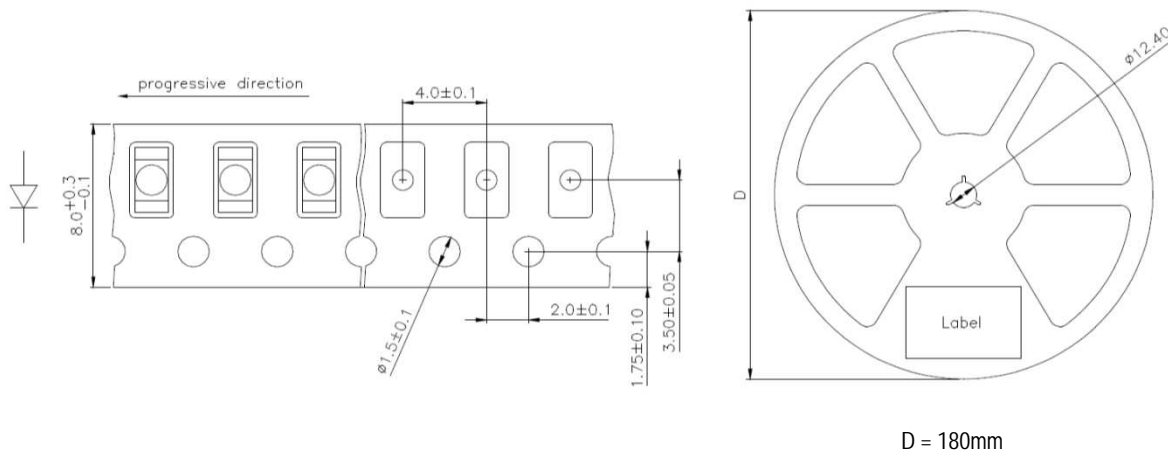

Tape and Reel - Suffice to the part number	
Ex:	MTXXXXX-T05 = 500 piece reel
Code	Components per reel
T05	500
T1	1000
T2	2000
T25	2500
T3	3000

Packing: The reel is seaLED in special plastic bag with integrate ESD protection (MIL - STD 81705) including a silica dry-pack